

3MP GMSL2 CAMERA

GENERAL DESCRIPTION

The camera is equipped with SONY CMOS image sensor ISX031 and Maxim GMSL2 serializer MAX96717F. It has an automotive-grade sensor with a well-tuned Image Signal Processor (ISP) that produces exceptional image quality, which comes with an IP67-rated enclosure – is supplied with an AA lens that is focused and glued in our factory.



KEY PARAMETERS

Sensor	SONY 2.95MP ISX031 RRGB
ISP	Built-in
Image Size	1/2.42 inch CMOS
Output Pixels	1920H*1536V
Pixel Size	3.0um*3.0um
Frame Rate	1920*1536@30fps
HDR Support	Yes
LFM	Yes
Output data	YUV422@8bit
Serializer	MAXIM MAX96717F
Camera Interface	GMSL2
Power Supply	9~16V POC
Current	<200mA@12VDC
Connector	Amphenol Fakra (Z Code)
Operating temp. range	-40~+85°C
Dimensions	W: 25mm, L:25mm, H:18.6mm
Weight	<50g



Features

- Output format: Uncompressed YUV422 format
- AA IP67 compliant lens focused and glued at our factory
- External trigger support
- Multi-Camera synchronization Support
- Support different focal length lens



Application

- Automotive
- ADAS + Viewing Fusion
- High Dynamic Range Imaging
- Autonomous Driving
- Robots





HARDWARE SETTING

Serializer	
Model	Max96717F
I2C Address	0x80(8bit address)
Rate	GMSL2 (3G bps)

Sensor	
Model	ISX031
I2C Address	0x34 (8bit address)
Frame Sync	Controlled by Max96717F MFP7
Reset	Controlled by Max96717F MFP0

Interface Circuit Diagram





BLOCK DIAGRAM

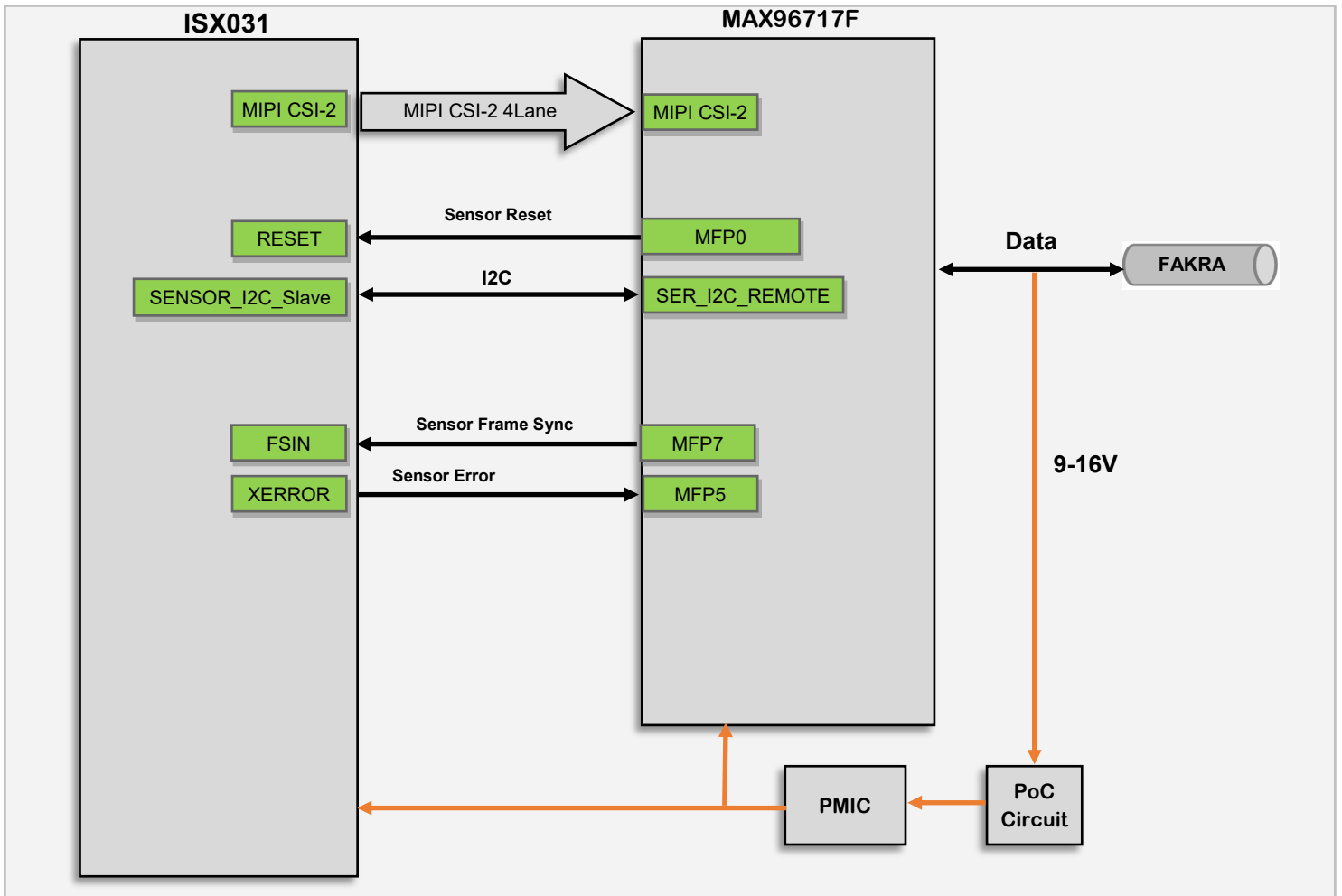

Block Diagram

- ※ The camera module has a built-in ISP that outputs YUV data. The backend does not need to configure an image sensor, but only needs to configure SerDes;
- ※ For SerDes setting code, please contact Sales@sensing-wolrd.com ;
- ※ The camera support store camera internal parameters, if you need to obtain the internal parameters reading method, please note before placing the order



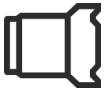

MODEL AND LENS

Model	HFOV	VFOV	F.No	EFL	Max Optical Distortion	Water-proof	Lens Mount
SG3S-ISX031C-GMSL2F-H30X	30°	24°	1.6	10.96mm	-2.5%	IP67	M12
SG3S-ISX031C-GMSL2F-H60FA	60°	46°	1.6	5.8mm	-21%	IP67	AA
SG3S-ISX031C-GMSL2F-H100F1A	100°	78°	1.6	3.55mm	-58%	IP67	AA
SG3S-ISX031C-GMSL2F-H120UA	118°	92°	2	3mm	-92%	IP67	AA
SG3S-ISX031C-GMSL2F-H190XA	196°	154°	2.0	1.51mm	-155%	IP67	AA



DIMENSIONS

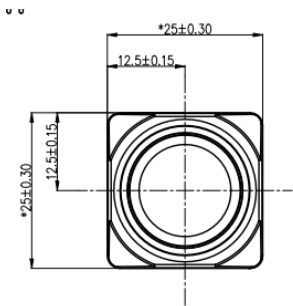

Front View

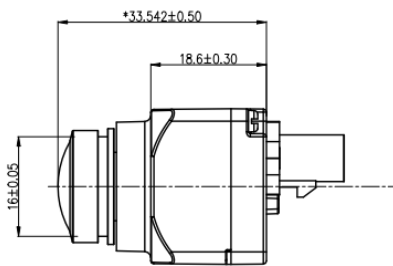

Side View

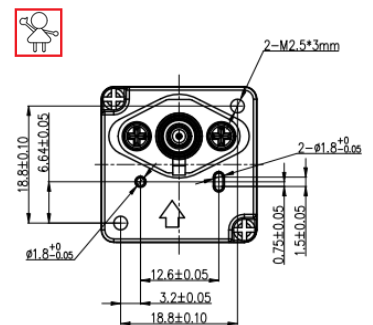

Rear View

Note:



This icon indicates the imaging direction is positive.



△ The height of this module varies when matching different lenses. Please refer to 3D digital analog size for details.

Dimension



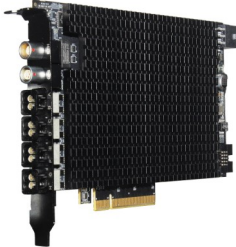

PLATFORMS SUPPORT

Platforms	Product Link
<p>NVIDIA Jetson platforms</p> 	<p>Provide development driver package</p> <p>https://www.sensing-world.com/jetson_camera_ecosystem</p> 
<p>SerDes Camera to USB Converter</p>	<p>Compatible with UVC protocol</p> <p>https://www.sensing-world.com/USB_Converter</p> 
<p>CoaxCapture II GMSL Capture Card</p>	<p>Provide development driver package</p> <p>https://www.sensing-world.com/Coaxcapture_Card</p> 

※ For development support, please contact Sales@sensing-wolrd.com;





DEVELOPMENT KIT

◇ SerDes Camera to USB Converter



- SG3S-ISX031C-GMSL2F can connect to **SG8-U30-GMSL2** as a USB 3.0 camera .
- USB Camera Part Number: **SG3S-ISX031C-GMSL2F-U30-Hxxx** (include 1xSG8-U30-GMSL2 and 1xSG3S-ISX031C-GMSL2F)

◇ KEY FEATURES

- USB 3.0 Super Speed support
- UVC compliance
- Provide customization services
- Power Supply by USB interface
- Weight: <300g
- Single Coax Cable transmit up to 20 meters PoC (Power over Cable)
- Support Windows only

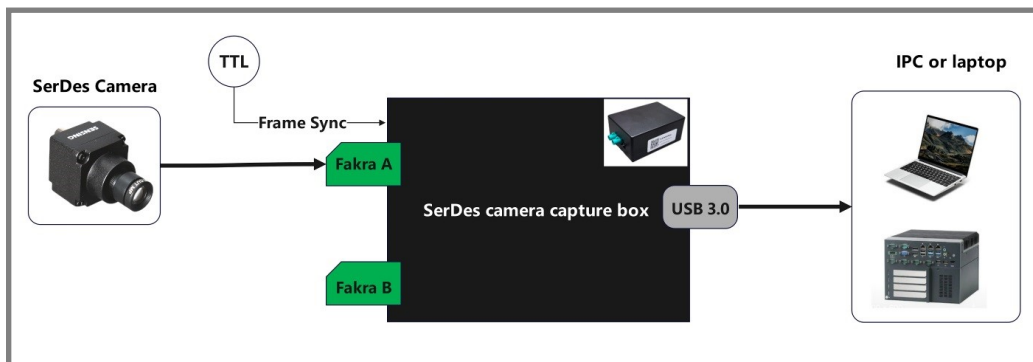

※ Support connected one camera only;





DEVELOPMENT KIT

◇ **CoaxCapture II GMSL Capture Card**

CCG3-8H

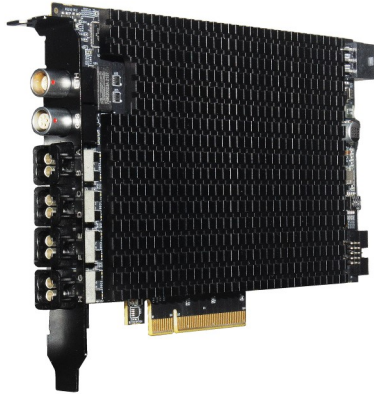

CCG3-4H

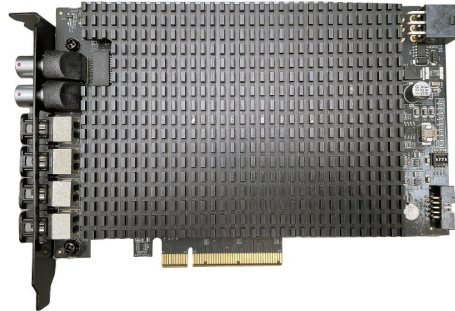

- SG3S-ISX031C-GMSL2F can connect to **CCG3-4H/8H**.

◇ **KEY FEATURES**

- CCG3-8H at most can support connect 8 pcs of this camera at the same time
- CCG3-4H at most can support connect 4 pcs of this camera at the same time
- PCI-e Gen3*8lane support x86 architecture
- Support external trigger synchronization
- Support GPS Timing synchronization
- Support network PTP timing

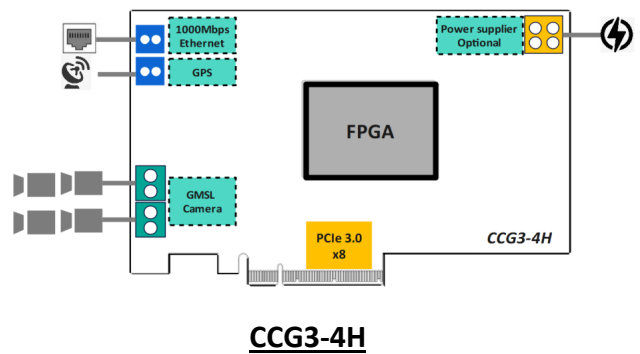
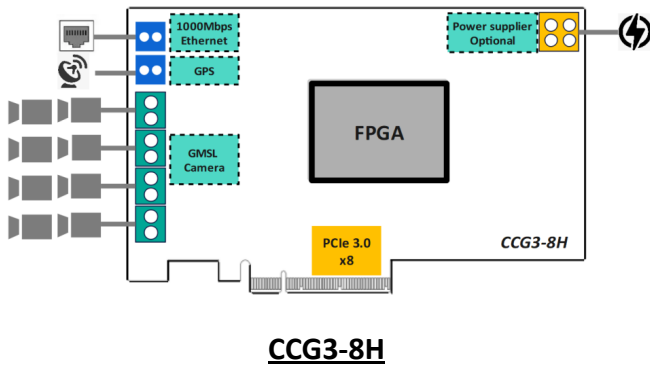



ACCESSORIES

◇ **Coaxial Cable**

Product Name	Order PN#	Specification
Mini-fakra Coaxial Cable 4-in-1(Rosenberg)	R4JC-JC-ZZZZ-0500L	Mini-fakra, 4 in 1, 0.5m, Female to Female
Mini-fakra Coaxial Cable 4-in-1 (TE)	T4JC-PC-ZZZZ-0500A	Mini-fakra, 4 in 1, 0.5m, Male to Female
Mini-fakra Coaxial Cable 4-in-1(Rosenberg)	R4JC-PC-ZZZZ-0500L	Mini-fakra, 4 in 1, 0.5m, Male to Female
Mini-fakra Coaxial Cable 4-in-1 (TE)	T4JC-JC-ZZZZ-0500A	Mini-fakra, 4 in 1, 0.5m, Female to Female
Camera coaxial Cable	SG-JSZPSZ2000L	2M, Male to Female, IP67
Camera coaxial Cable	SG-JSZJSZ2000L	2M, Female to Female, IP67
Camera coaxial Cable	SG-JSZPSZ3000L	3M, Male to Female, IP67
Camera coaxial Cable	SG-JSZJSZ3000L	3M, Female to Female, IP67
Camera coaxial Cable	SG-JSZPSZ5000L	5M, Male to Female, IP67
Camera coaxial Cable	SG-JSZJSZ5000L	5M, Female to Female, IP67
Camera coaxial Cable	SG-JSZJSZ7000L	7M, Female to Female, IP67
Camera coaxial Cable	SG-JSZJSZ8000L	8M, Female to Female, IP67
Camera coaxial Cable	SG-JSZPSZL100L	10M, Male to Female, IP67
Camera coaxial Cable	SG-JSZJSZL100L	10M, Female to Female, IP67
Camera coaxial Cable	SG-JSZJSZL120L	12M, Female to Female, IP67
Camera coaxial Cable	SG-JSZJSZL160L	16M, Female to Female, IP67
Camera coaxial Cable	SG-JSZJSZL200L	20M, Female to Female, IP67

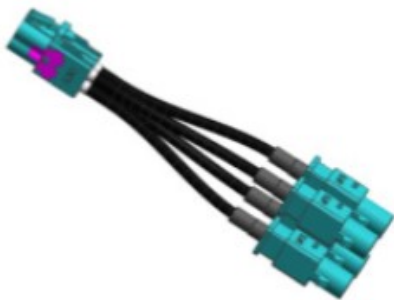



Revision History

Version	Description	Release date
Rev1	First Release	Sep.2023
Rev2	Added H30XA and H120UA modules	Mar.2024
Rev3	H30XA module is changed to the H30X module	Jun.2024





Contact Us

SZ Sensing TECH CO.,LTD

HQ Address: 8/F,block B, building 1,wisdom home,No.76,Baohe Avenue,Baolong street, Longgang District, Shenzhen

Phone: +86-755-28990915

Email: Sales@sensing-world.com

Company Website: www.sensing-world.com

Online Message: <https://www.sensing-world.com/lxwm>



WECHAT



SKYPE



WhatsApp

